

## Specifications

UL Electrical Ratings Q	6A @ 36VDC, Resistive, 40T120, 50K cycles
	10.1A @ 125VAC / 250VAC, Resistive 40T120, 50K cycles
	10.1A @ 125VAC / 250VAC, General Purpose 40T120, 50K cycles
	6(3)A @ 125VAC / 250VAC, Resistive-Motor, 40T120, 50K cycles

Contact Resistance	Without Wire : ≤ 50m Ω initial With Wires : ≤ 100m Ω initial
Mechanical Life	1,000,000 cycles typical
Actuation Forces	180gF or 300gF
Dielectric Strength	1000Vrms min. @ sea level
Insulation Resistance	≥ 100MΩ min
Operating Temperature	-40°C to +120°C
Storage Temperature	-40°C to +120°C
Sealing Degree	IP67

## Materials

Base / Cover	Polybutylene Terephthalate (PBT), UL94-V0
Pin Plunger	Polybutylene Terephthalate (PBT), UL94-V0
Contacts	Silver Alloy Rivets or Gold Plated Silver Rivets
Terminals	Copper Alloy, Silver Plated
Wire	UL1015 20AWG 300mm

## Ordering Information

1. Series	VM3S	C	Q	F180	3	L06
2. Circuit	<p>VM3S</p> <p>A = SPST NO B = SPST NC C = SPDT</p>					
3. Contact Material	<p>Q = Silver G = Gold over Silver Plated <sup>(1)</sup></p>					
4. Operating Force without lever	<p>Contact factory for other force options</p> <p>F180 = 180gF F300 = 300gF</p>					
5. Termination	<p>2 = 0.187" Quick Connect 3 = 300mm UL 1015 20AWG Wire</p>					
6. Actuator (Lever)	<p>Contact factory for other lever options</p> <p>L00 = Pin plunger L01 = Roller lever, standard L02 = Simulated roller L03 = Hinge lever, standard L04 = Hinge lever, short L06 = Roller lever, short</p>					

(1) Gold over Silver Plated contact material electrical rating is 0.1A @ 125VAC / 30VDC, Resistive, 40T4120, 1M cycles

# VM3S

## IP67 Sealed Snap Action

### Dimensions - Standard

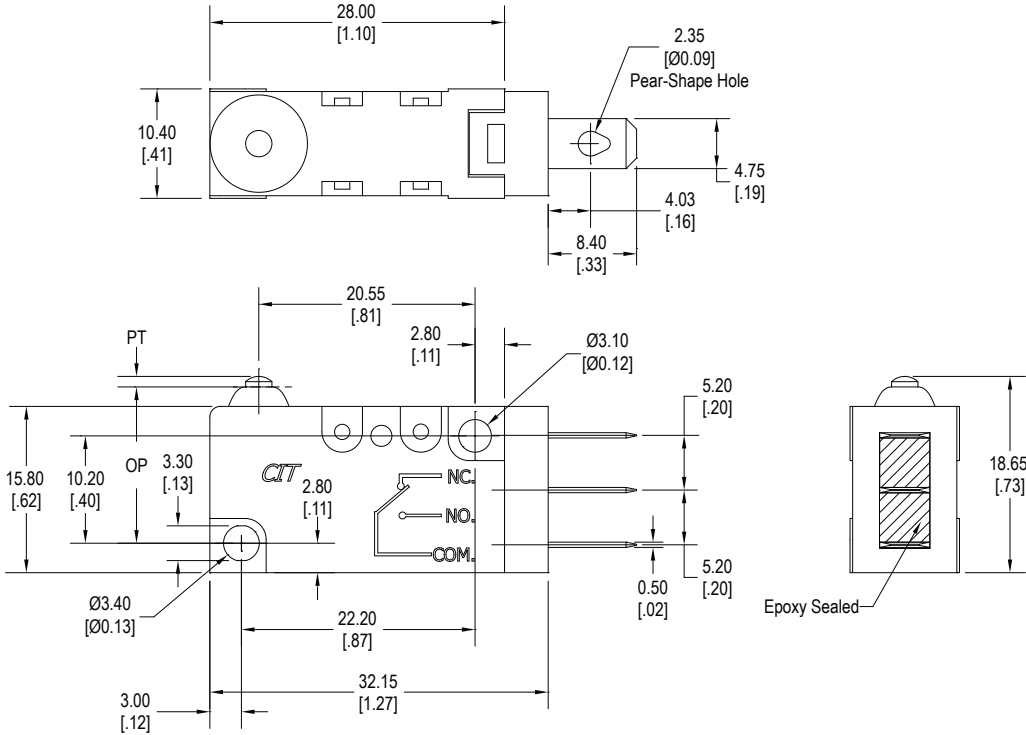

### Dimensions - With Wire

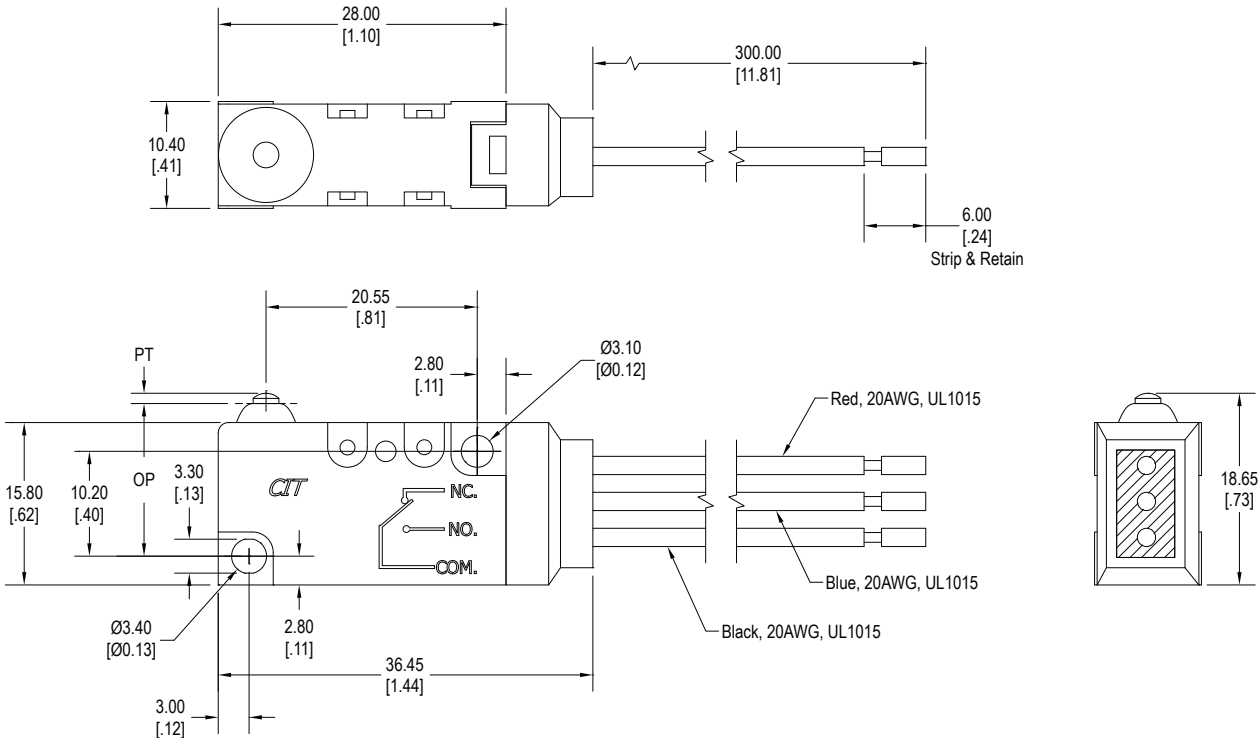

## Switch Characteristics

Actuators (Levers)	Operating Force (grams)		Release Force (grams) min.		Free Position all forces (mm)	Pre-Travel (PT) all forces max (mm)		Operating Position (OP) all forces (mm)		Over Travel min		Movement Differential all forces max (mm)	
	180gF	300GF	180gF	300gF		180gF	300GF	180gF	300GF	180gF	300GF	180gF	300GF
L00	180±50	320±50	100gF	250gF	15.75±0.3	1.6	2.0	14.75±0.5	14.75±0.5	0.8	0.6	0.8	0.8
L01	140±60	210±60	50gF	100gF	22.30±0.8	2.5	3.0	20.50±0.8	20.20±0.8	1.0	0.8	1.3	1.3
L02	120±50	200±50	50gF	180gF	20.80±0.8	3.0	3.0	18.70±0.8	18.30±0.8	1.0	0.6	1.3	1.5
L03	120±50	180±50	40gF	80gF	17.50±0.8	3.5	3.5	15.30±0.8	14.90±0.8	1.0	1.0	1.5	1.5
L04	190±80	300±80	80gF	250gF	16.50±0.6	1.8	2.0	15.30±0.8	15.00±0.8	0.5	0.5	1.0	1.0
L06	240±80	380±80	100gF	160gF	21.50±0.6	1.5	1.7	20.5±0.8	20.30±0.8	0.5	0.3	1.0	1.0

## Panel Mounting

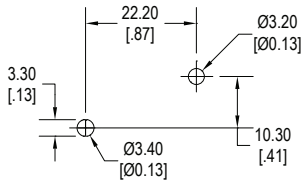

## Schematic

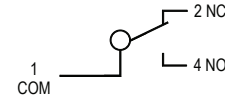

## Terminal Options - .187" Quick Connect

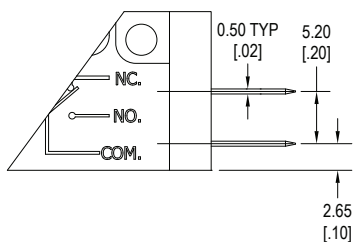

**SPST N.O.**

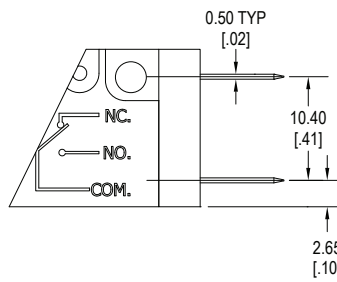

**SPST N.C.**

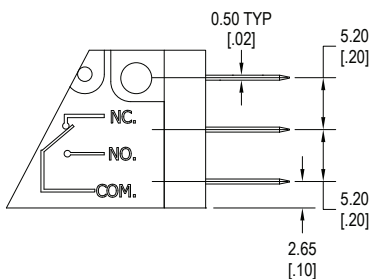

**SPDT**

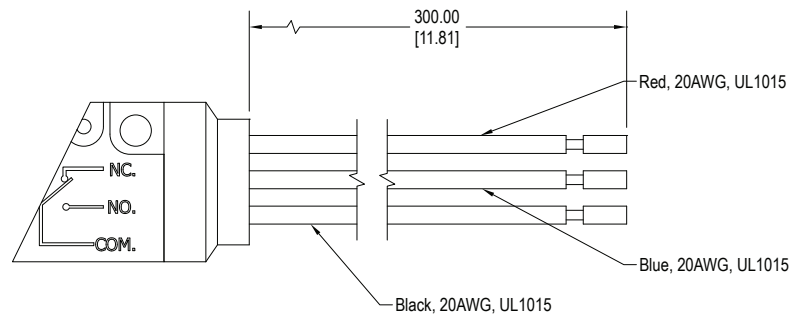

**SPDT with wires**

# VM3S

IP67 Sealed Snap Action

## Levers

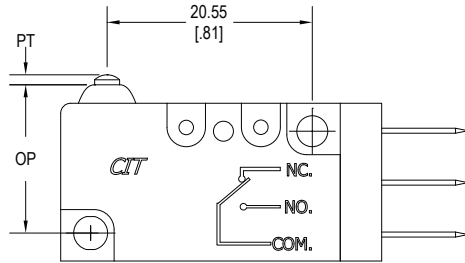

**L00**

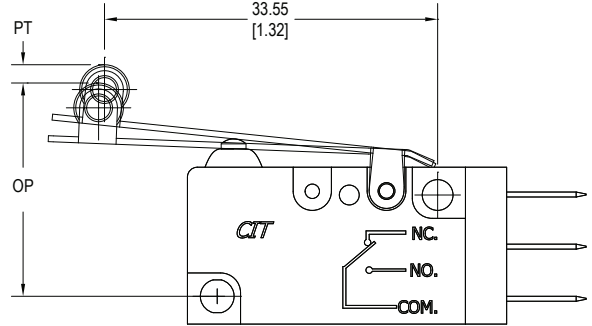

**L01**

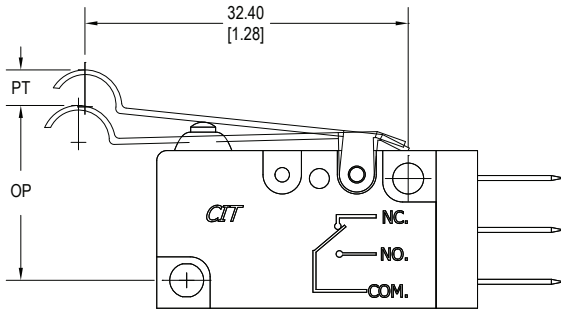

**L02**

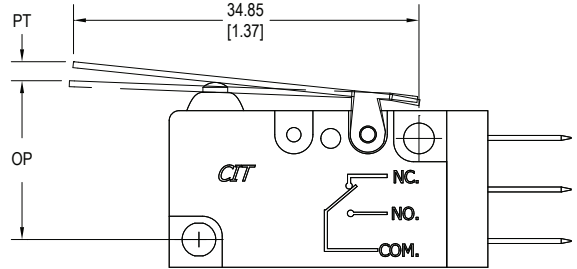

**L03**

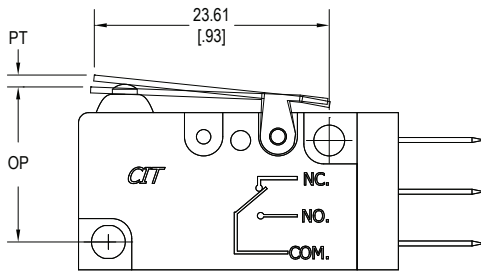

**L04**

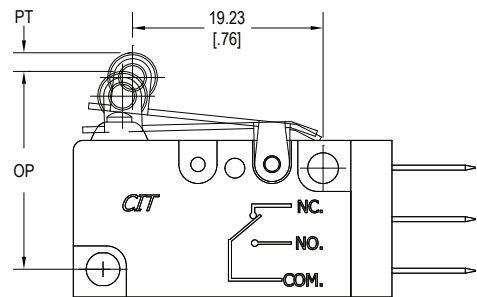

**L06**