

J115F1E, J115F2E, J115F3E

E197852

21.5 x 15.8 x 16.5 mm

Features

- 30A economical version
- Small size and light weight, low coil power consumption
- Heavy contact load, strong shock and vibration resistance

Contact Data*

TÜV Contact Rating N.O.	30A @ 240VAC; 14VDC
N.C.	20A @ 240VAC; 14VDC
UL Contact Rating N.O.	30A @ 240VAC Resistive
N.C.	20A @ 240VAC Resistive
Contact Arrangement	1A = SPST N.O. 1B = SPST N.C. 1C = SPDT N.O.

Contact Resistance	< 30 milliohms initial
Contact Material	AgSnO ₂ , AgCdO
Maximum Switching Power	840W, 7200VA
Maximum Switching Voltage	277VAC, 110VDC
Maximum Switching Current	30A

Coil Data DC Parameters*

Coil Voltage VDC		Coil Resistance Ω +/- 10%		Pick Up Voltage VDC (max)	Release Voltage VDC (min)	Coil Power W	Operate Time ms	Release Time ms
Rated	Max	.6W	.9W	75% of rated voltage	10% of rated voltage			
5	6.5	42	28	3.75	.5	.60 .90	15	10
9	11.7	135	90	6.75	.9			
12	15.6	240	160	9.00	1.2			
24	31.2	960	640	18.00	2.4			
48	62.4	3840	2560	36.00	4.8			
110	140.3	20167	13445	82.50	11.0			

General Data*

Electrical Life @ rated load	100K cycles, average	
Mechanical Life	10M cycles, average	
Insulation Resistance	100M Ω min. @ 500VDC initial	
Dielectric Strength,	Coil to Contact	4000V rms min. @ sea level initial (H = high dielectric strength option)
	Contact to Contact	2500V rms min. @ sea level initial 1500V rms min. @ sea level initial
Shock Resistance	200m/s ² for 11 ms	
Vibration Resistance	1.50mm double amplitude 10~40Hz	
Terminal (Copper Alloy) Strength	10N	
Operating Temperature	-55°C to +125°C F Class	-40°C to +85°C B Class
Storage Temperature	-55°C to +155°C F Class	-40°C to +115°C B Class
Solderability	260°C for 5 s	
Weight	37g	

* Values can change due to the switching frequency, desired reliability levels, environmental conditions and in-rush load levels. It is recommended to test actual load conditions for the application. It is the user's responsibility to determine the performance suitability for their specific application. The use of any coil voltage less than the rated coil voltage may compromise the operation of the relay.

J115F1E, J115F2E, J115F3E

Ordering Information

1. Series	J115F3E	1A	S	12D	S	X	.9	B	C
J115F1E (PC terminals only) J115F2E (PC and quick connect terminals) J115F3E (quick connect terminals only)									
2. Contact Arrangement									
1A = SPST N.O. 1B = SPST N.C. 1C = SPDT									
3. Profile									
S = Standard Profile L = Low Profile *J115F2E & J115F3E styles only N = No cover *J115F1E & J115F2E styles only									
4. Coil Voltage									
5D = 5VDC 9D = 9VDC 12D = 12VDC 24D = 24VDC 48D = 48VDC 110D = 110VDC									
5. Sealing Option									
S = Sealed X = No cover, non-sealed									
6. Dielectric Strength Option									
H = High dielectric strength *available with J115F1E only X = Standard dielectric strength									
7. Coil Power									
.9 = .9W DC Coil .6 = .6W DC Coil									
8. Insulation									
B = B Class F = F Class									
9. Contact Material									
Z = AgSnO ₂ C = AgCdO									

Dimensions - J115F1E

Units = mm

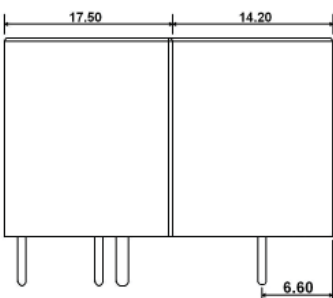

S - Standard Profile

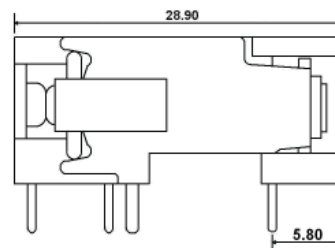
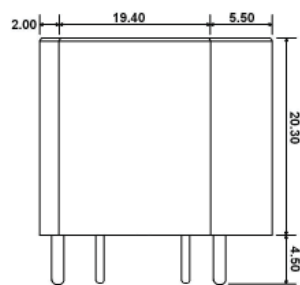

N - No Cover

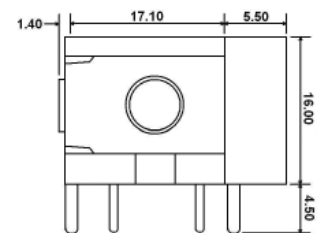

J115F1E, J115F2E, J115F3E

Dimensions - J115F2E

Units = mm

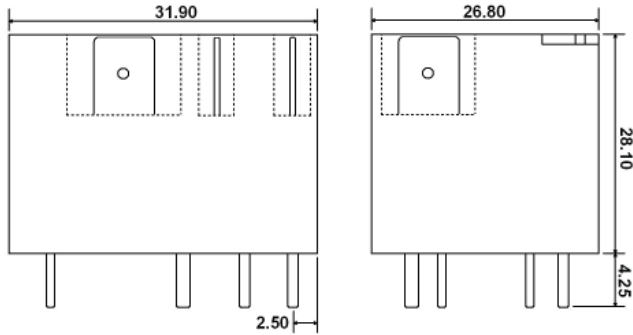

S = Standard Profile

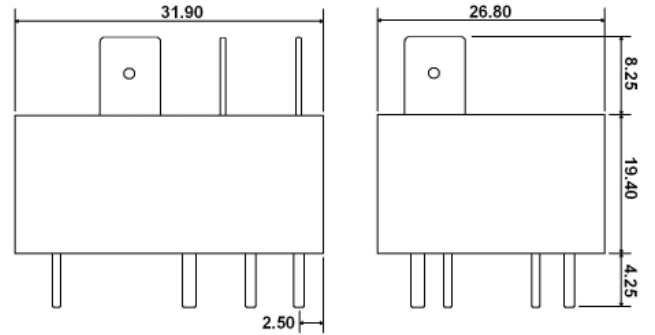

L = Low Profile

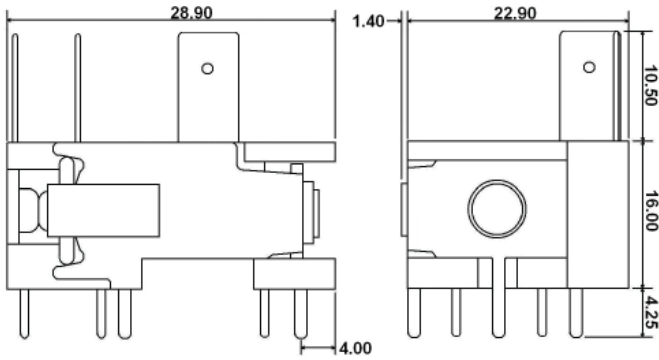

N = No Cover

**Quick Connect Terminals:
 Contacts - 6.35 x .81mm (.250" x .032")

Dimensions - J115F3E

Units = mm

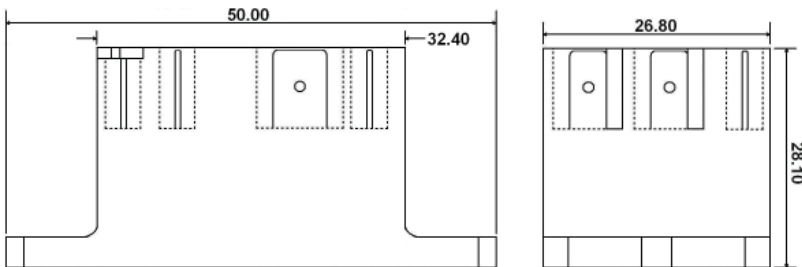

S = Standard Profile

**Quick Connect Terminals:
 Contacts - 6.35 x .81mm (.250" x .032")
 Coil - 4.75 x .50mm (.187" x .020")

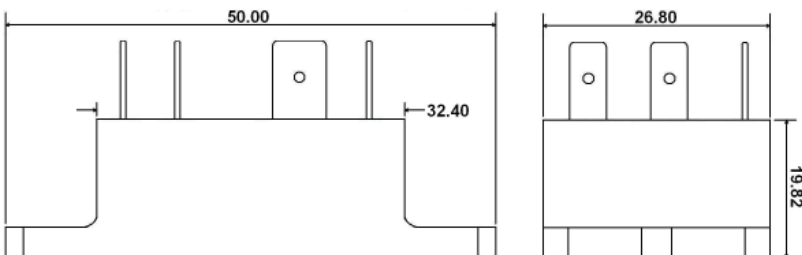

L = Low Profile

**Quick Connect Terminals:
 Contacts - 6.35 x .81mm (.250" x .032")
 Coil - 4.75 x .50mm (.187" x .020")

J115F1E, J115F2E, J115F3E

Schematics, PC Layouts & Panel Layouts

J115F1E

Bottom View

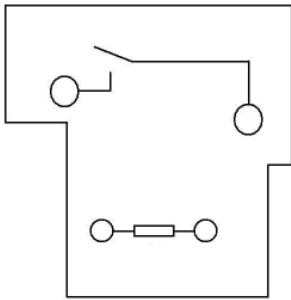

1A

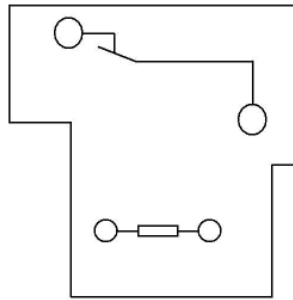

1B

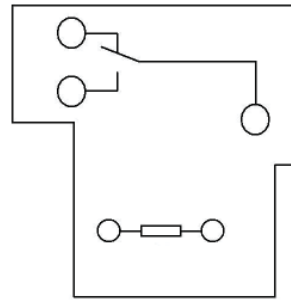

1C

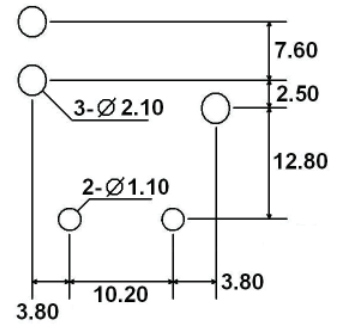

J115F2E

Bottom View

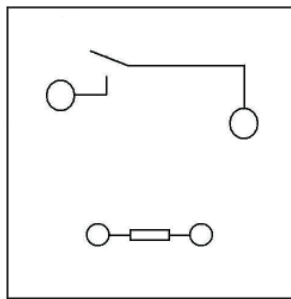

1A

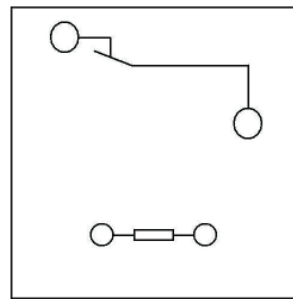

1B

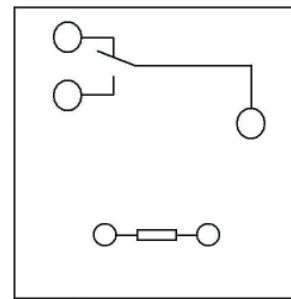

1C

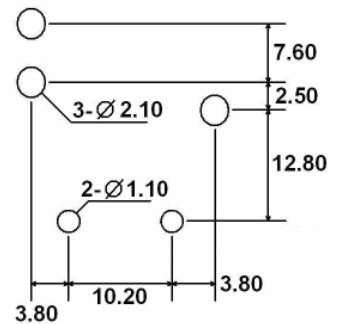

J115F3E

Top View

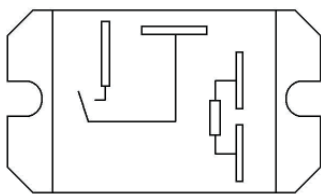

1A

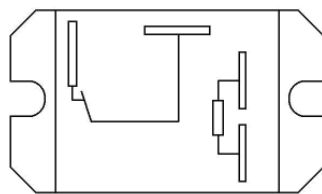

1B

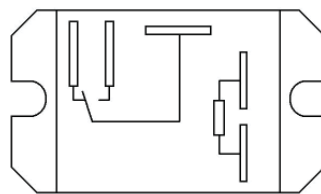

1C

